

修订 REV	标记 MARK	修改摘要 REVISION DESCRIPTION	签名 SIGNATURE	日期 DATE
AO		NEW RELEASE	WANG	2015-10-09

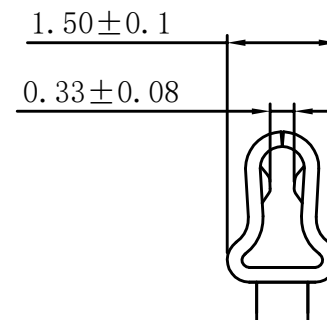

C-C旋转

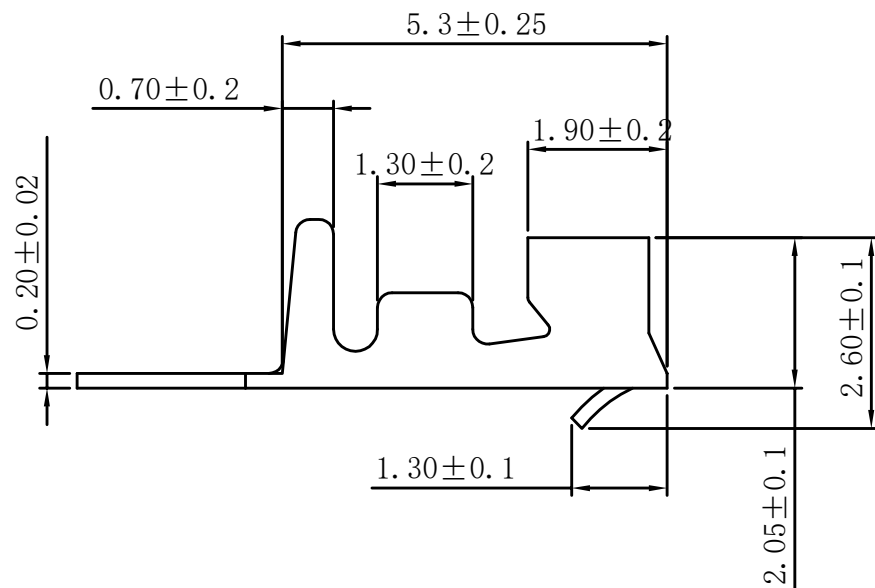
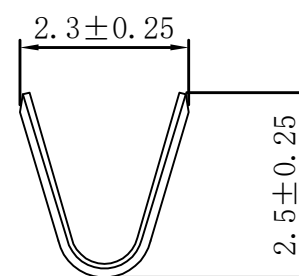
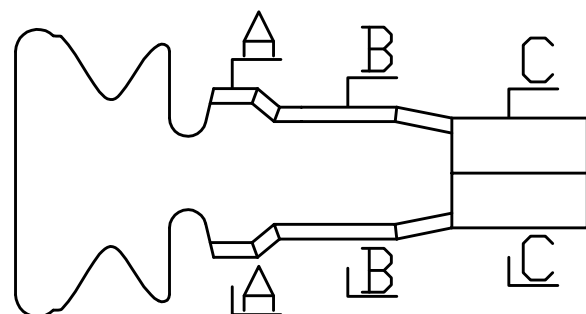

A-A旋转

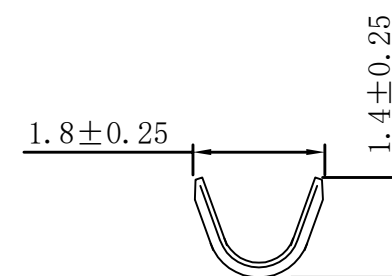

B-B旋转

注明:

- 1: 零件外观要求无毛刺和机械损伤;
- 2: 镀锡镍底, 镀层均匀, 无雾斑。



深圳市华德共创科技有限公司

Shenzhen Huade co-create Technology Co.,LTD

TEL : 0755-27129737 FAX : 0755-29940187

-TOLERANCES- UNLESS OTHERWISE SPECIFIED 公差参数表						TITLE: 2.00mm Pitch 产品名称: Crimp Terminal			
X.X	±0.30	X.X°	±3°	APPD: 核准:	XIE	PART NO: 产品编号: HDGC2013-T			
X.XX	±0.30	X.XX°	±2°	CHECK: 校对:	WANG	DATE	SCALE	UNIT	CODE NUMBER
X.XXX	±0.10	X.XXX°	±1°	DRAW: 绘图:	WANG	2015-10-09	5:1	mm	A001

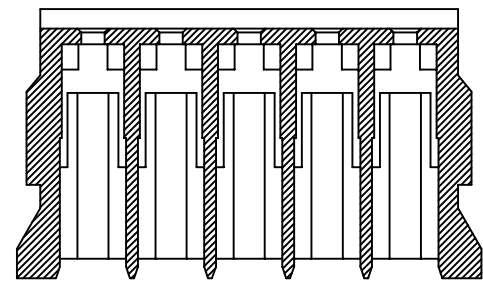
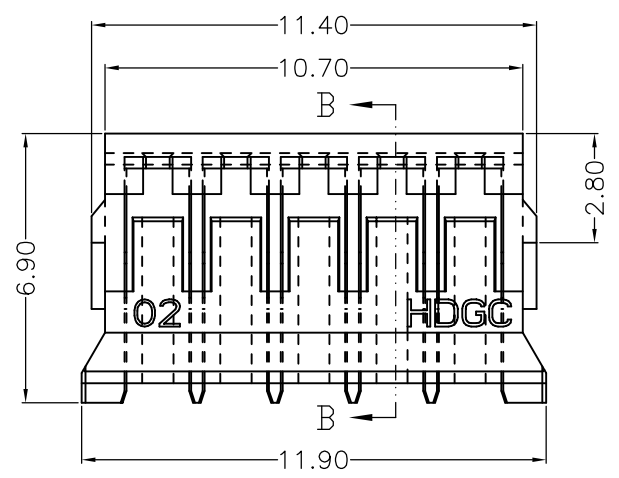
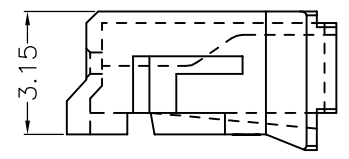
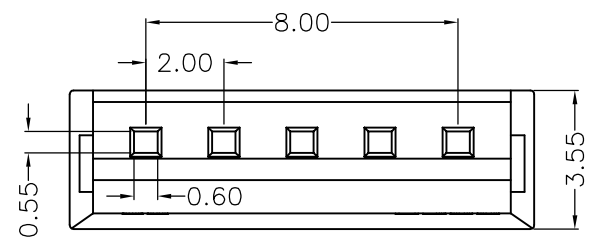

修订 REV	标记 MARK	修改摘要 REVISION DESCRIPTION	签名 SIGNATURE	日期 DATE
AO		NEW RELEASE	WANG	2013-05-07

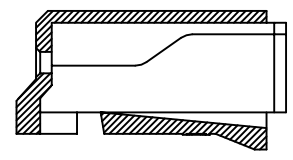
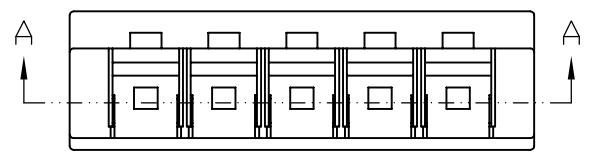

SECTION A-A



SECTION B-B

		深圳市华德共创科技有限公司 Shenzhen Huade co-create Technology Co.,LTD TEL : 0755-27129737 FAX : 0755-29940187			
-TOLERANCES- UNLESS OTHERWISE SPECIFIED 公差参数表		 		TITLE: 产品名称 : 2.00mm Pitch Housing	
X.X	±0.30	X.X°	±3°	APPD: 核准 :	XIE
X.XX	±0.30	X.XX°	±2°	CHECK: 校对 :	WANG
X.XXX	±0.10	X.XXX°	±1°	DRAW: 绘图 :	WANG
PART NO: 产品编号 :		HDGC2013H-5P			
DATE		SCALE	UNIT	CODE NUMBER	
2013-05-07		4:1	mm	A001	