

修订 REV	标记 MARK	修改摘要 REVISION DESCRIPTION	签名 SIGNATURE	日期 DATE
AO		NEW RELEASE	WANG	2020-07-22

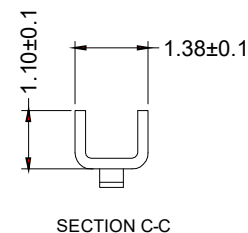
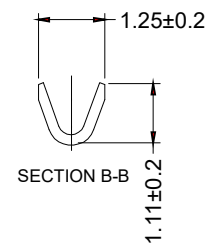
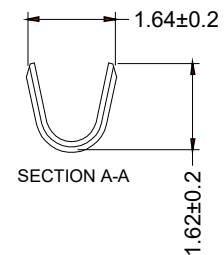
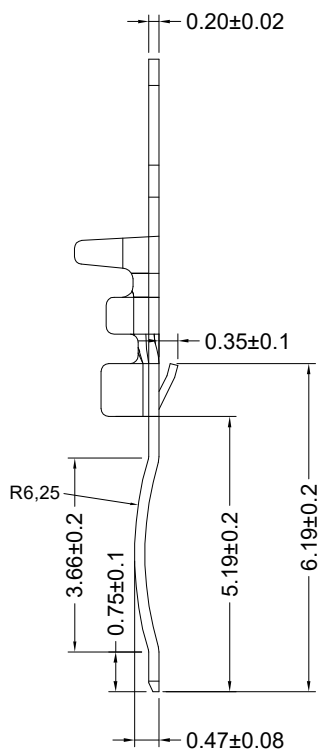
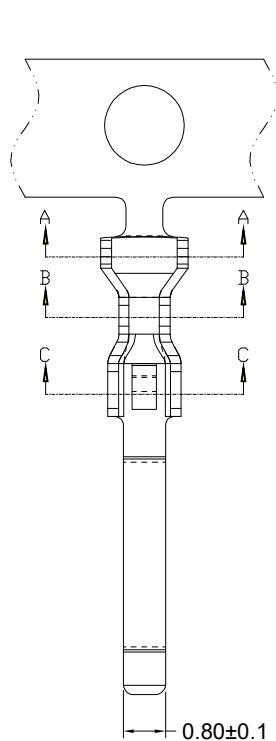
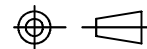

材质: 磷铜 C5191 0.20±0.02mm  
 电镀: 先镀后冲, 镀锡镍底

 <b>深圳市华德共创科技有限公司</b> Shenzhen Huade co-create Technology Co.,LTD TEL : 0755-27129737 FAX : 0755-29940187		TITLE: 2.30mm Pitch 产品名称: Crimp Terminal	
-TOLERANCES- UNLESS OTHERWISE SPECIFIED 公差参数表			
X.X	±0.30	X.X°	±3°
X.XX	±0.30	X.XX°	±2°
X.XXX	±0.10	X.XXX°	±1°
APPD: 核准: XIE		PART NO: HDGC2301-T 产品编号:	
CHECK: 校对: WANG		DATE	SCALE
DRAW: 绘图: WANG		2020-07-22	5:1
		UNIT	CODE NUMBER
		mm	A001

修订 REV	标记 MARK	修改摘要 REVISION DESCRIPTION	签名 SIGNATURE	日期 DATE
AO		NEW RELEASE	WANG	2020-07-22

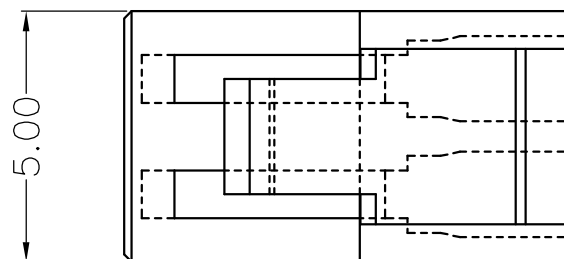
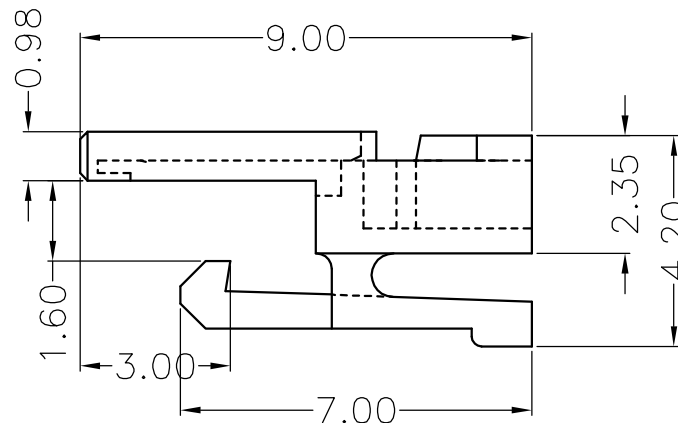
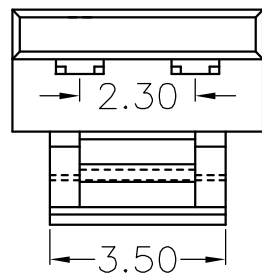

深圳市华德共创科技有限公司

Shenzhen Huade co-create Technology Co.,LTD

TEL : 0755-27129737 FAX : 0755-29940187

-TOLERANCES-  
UNLESS OTHERWISE SPECIFIED  
公差参数表

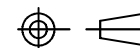



TITLE:  
产品名称 : 2.30mm Pitch Housing

X.X	±0.30	X.X°	±3°	APPD: 核准 : XIE	PART NO: 产品编号 : HDGC2301H			
X.XX	±0.30	X.XX°	±2°	CHECK: 校对 : WANG	DATE	SCALE	UNIT	CODE NUMBER
X.XXX	±0.10	X.XXX°	±1°	DRAW: 绘图 : WANG	2020-07-22	3:1	mm	A001

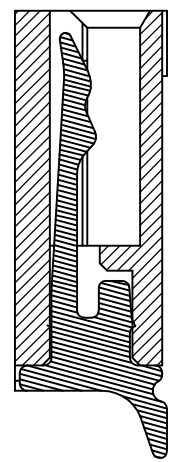
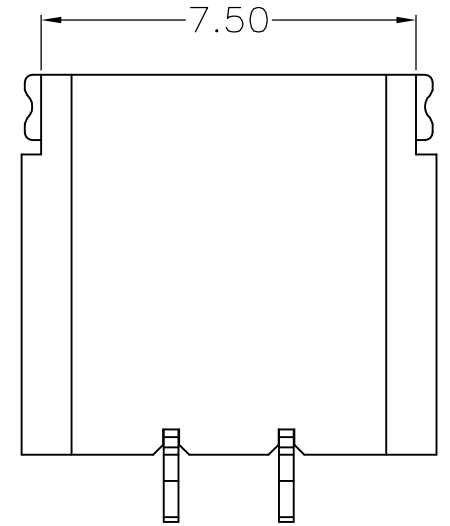
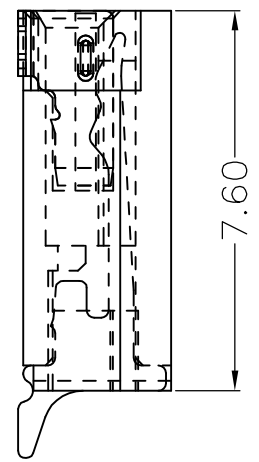
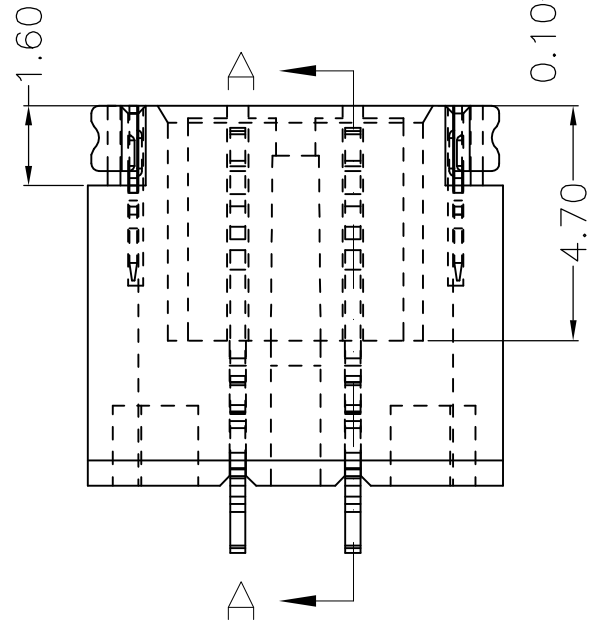
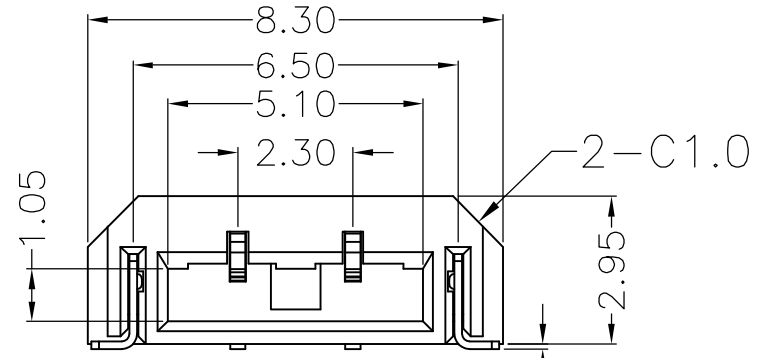
修订 REV	标记 MARK	修改摘要 REVISION DESCRIPTION	签名 SIGNATURE	日期 DATE
A0		NEW RELEASE	WANG	2020-07-11
A1		产品缩短0.5MM	WANG	2020-07-15





SECTION A-A

		<b>深圳市华德共创科技有限公司</b> Shenzhen Huade co-create Technology Co.,LTD TEL : 0755-27129737 FAX : 0755-29940187									
-TOLERANCES- UNLESS OTHERWISE SPECIFIED 公差参数表				 		TITLE: 2.30mm Pitch 产品名称: 90° Wafer					
X.X	±0.30	X.X°	±3°	APPD: 核准:	XIE			PART NO: 产品编号:	HDGC2301WR-2Y		
X.XX	±0.30	X.XX°	±2°	CHECK: 校对:	WANG			DATE	SCALE	UNIT	CODE NUMBER
X.XXX	±0.10	X.XXX°	±1°	DRAW: 绘图:	WANG			2020-07-15	5:1	mm	A001

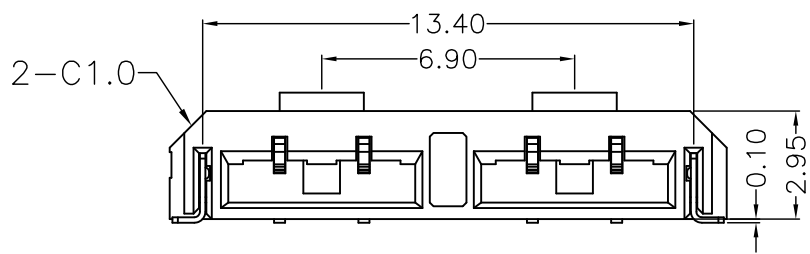
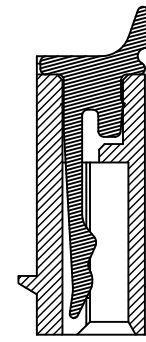
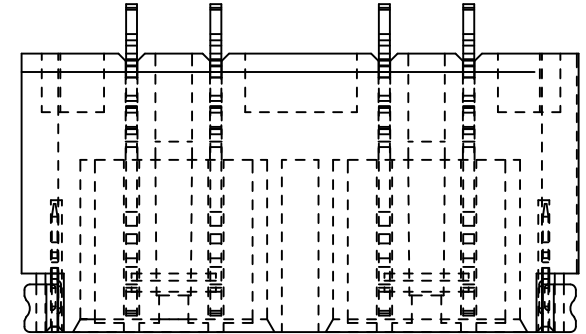
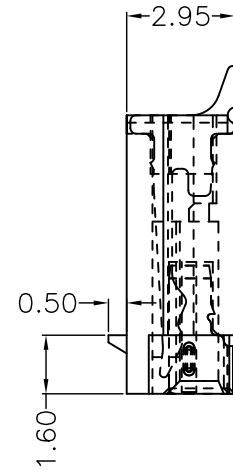
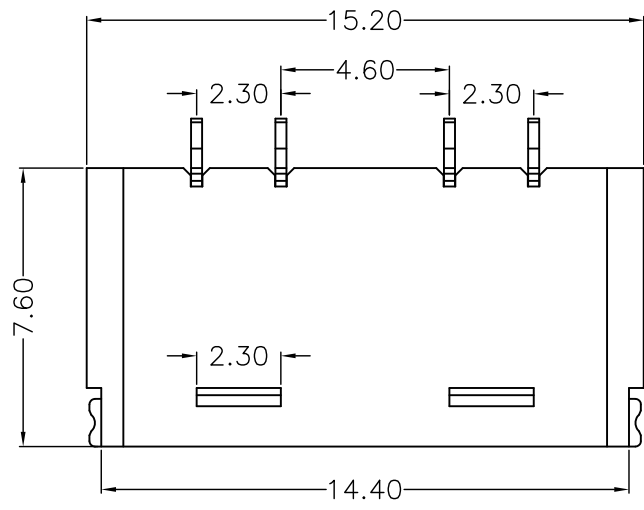
修订 REV	标记 MARK	修改摘要 REVISION DESCRIPTION	签名 SIGNATURE	日期 DATE
AO		NEW RELEASE	WANG	2020-07-22



		<b>深圳市华德共创科技有限公司</b> Shenzhen Huade co-create Technology Co.,LTD TEL : 0755-27129737 FAX : 0755-29940187								
-TOLERANCES- UNLESS OTHERWISE SPECIFIED 公差参数表				 		TITLE: 2.30mm Pitch 产品名称: 90° Wafer				
X.X	±0.30	X.X°	±3°	APPD: 核准:	XIE		PART NO: 产品编号:	HDGC2301WR-4Y		
X.XX	±0.30	X.XX°	±2°	CHECK: 校对:	WANG		DATE	SCALE	UNIT	CODE NUMBER
X.XXX	±0.10	X.XXX°	±1°	DRAW: 绘图:	WANG		2020-07-22	5:1	mm	A001