

Specifications

Current rating:50A AC,DC

Voltage rating:600V AC,DC

Temperature range:-25°C~+85°C

Contact resistance:10mΩMax.

Insulation resistance:1000MΩMin.

Withstanding voltage:5000V AC/minute

Compliant with RoHS and REACH

Meet the HF/Halogen Free,GWT/Glow wire Test (IEC60335-1) request,need to customize

Contact HDGC for details



HDGC10001 Series 10.00mm (.394") Pitch Wire to Board Connector

HDGC10001WVA-XP

10.00mm pitch 180° Wafer

Reference Informations:

- *Material:Pin:Brass/Tin over Nickel
Insulator:Nylon 46+30%GF,UL94V-0
- *Color:Black

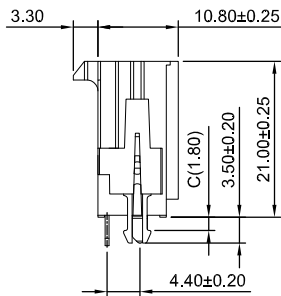
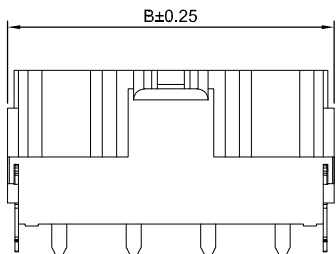
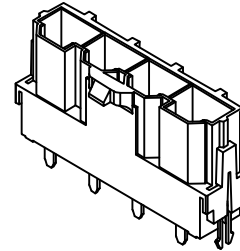
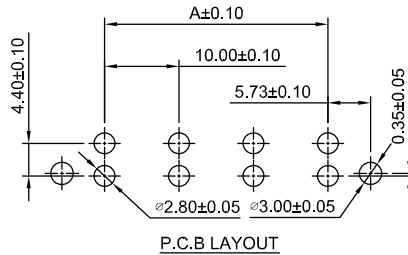
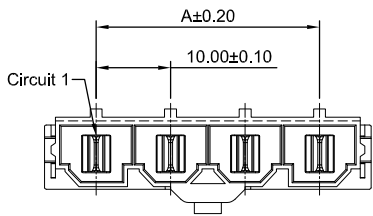

Ordering Information & Dimensions:

PART NO.	Dimensions	
	A	B
2P	10.00	23.82
3P	20.00	33.82
4P	30.00	43.82
5P	40.00	53.82
6P	50.00	63.82

Unit: mm

HDGC10001WRA-XP

10.00mm pitch 90° Wafer

Reference Informations:

- *Material:Pin:Brass/Tin over Nickel
Insulator:Nylon 46+30%GF,UL94V-0
- *Color:Black

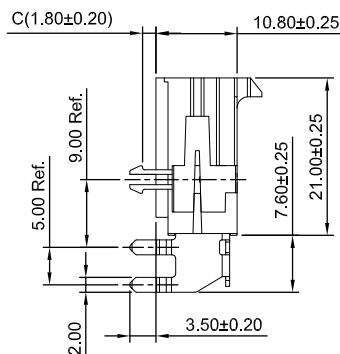
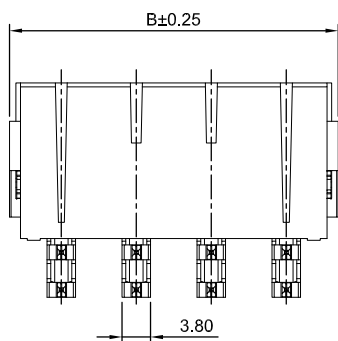
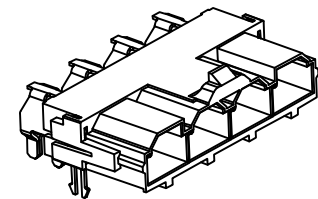
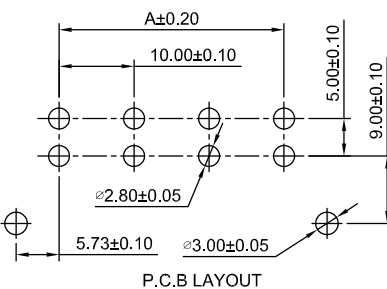
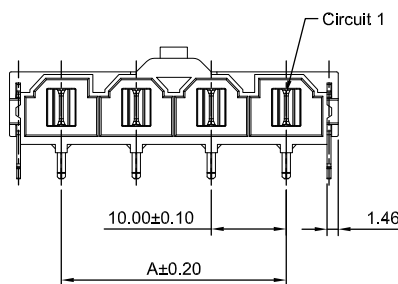

Ordering Information & Dimensions:

PART NO.	Dimensions	
	A	B
2P	10.00	23.82
3P	20.00	33.82
4P	30.00	43.82
5P	40.00	53.82
6P	50.00	63.82

Unit: mm



HDGC10001 Series 10.00mm (.394") Pitch Wire to Board Connector

HDGC10001WVA-XP-S

10.00mm pitch 180° Wafer

Reference Informations:

- *Material: Pin: Brass/Tin over Nickel
Insulator: Nylon 46+30%GF, UL94V-0
- *Color: Black

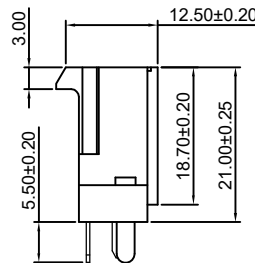
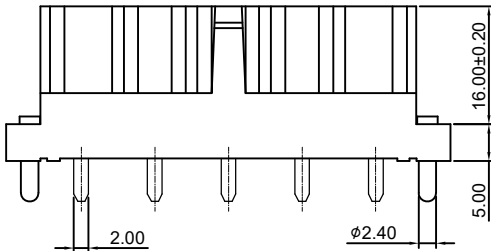
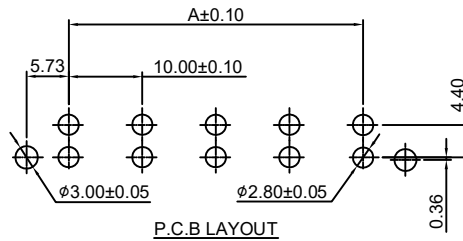
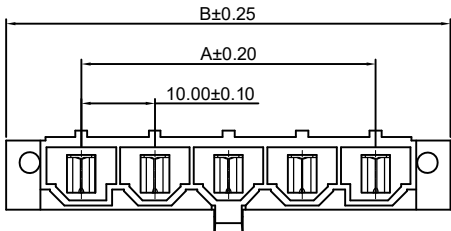
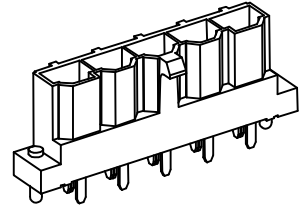

Ordering Information & Dimensions:

PART NO.	Dimensions	
	A	B
2P	10.00	30.30
3P	20.00	40.30
4P	30.00	50.30
5P	40.00	60.30
6P	50.00	70.30

Unit: mm

HDGC10001WRA-XP-S

10.00mm pitch 90° Wafer

Reference Informations:

- *Material: Pin: Brass/Tin over Nickel
Insulator: Nylon 46+30%GF, UL94V-0
- *Color: Black

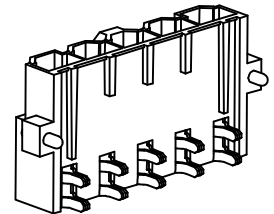
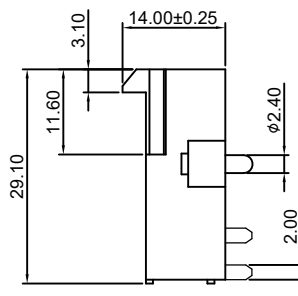
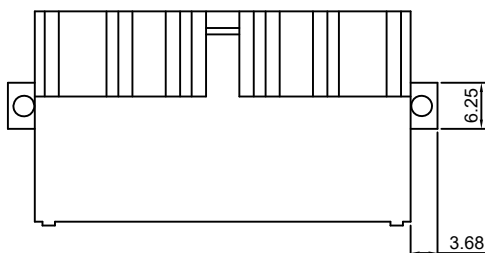
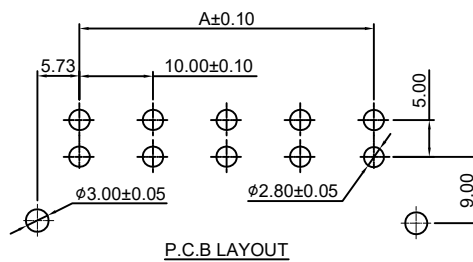
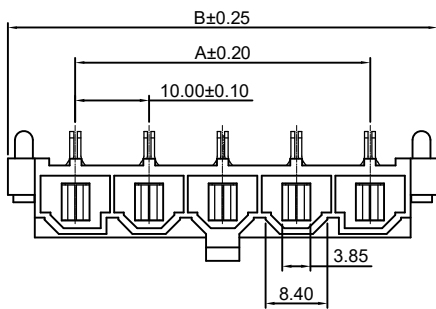

Ordering Information & Dimensions:

PART NO.	Dimensions	
	A	B
2P	10.00	30.30
3P	20.00	40.30
4P	30.00	50.30
5P	40.00	60.30
6P	50.00	70.30

Unit: mm