

Specifications

- Current rating: 2A AC, DC
- Voltage rating: 100V AC, DC
- Temperature range: -25°C ~ +85°C
- Contact resistance: 10mΩ Max.
- Insulation resistance: 1000MΩ Min.
- Withstanding voltage: 800V AC/minute
- *Compliant with RoHS and REACH*
- *Meet the HF/Halogen Free, need to customize*
- *Contact HDGC for details*

Assembly layout

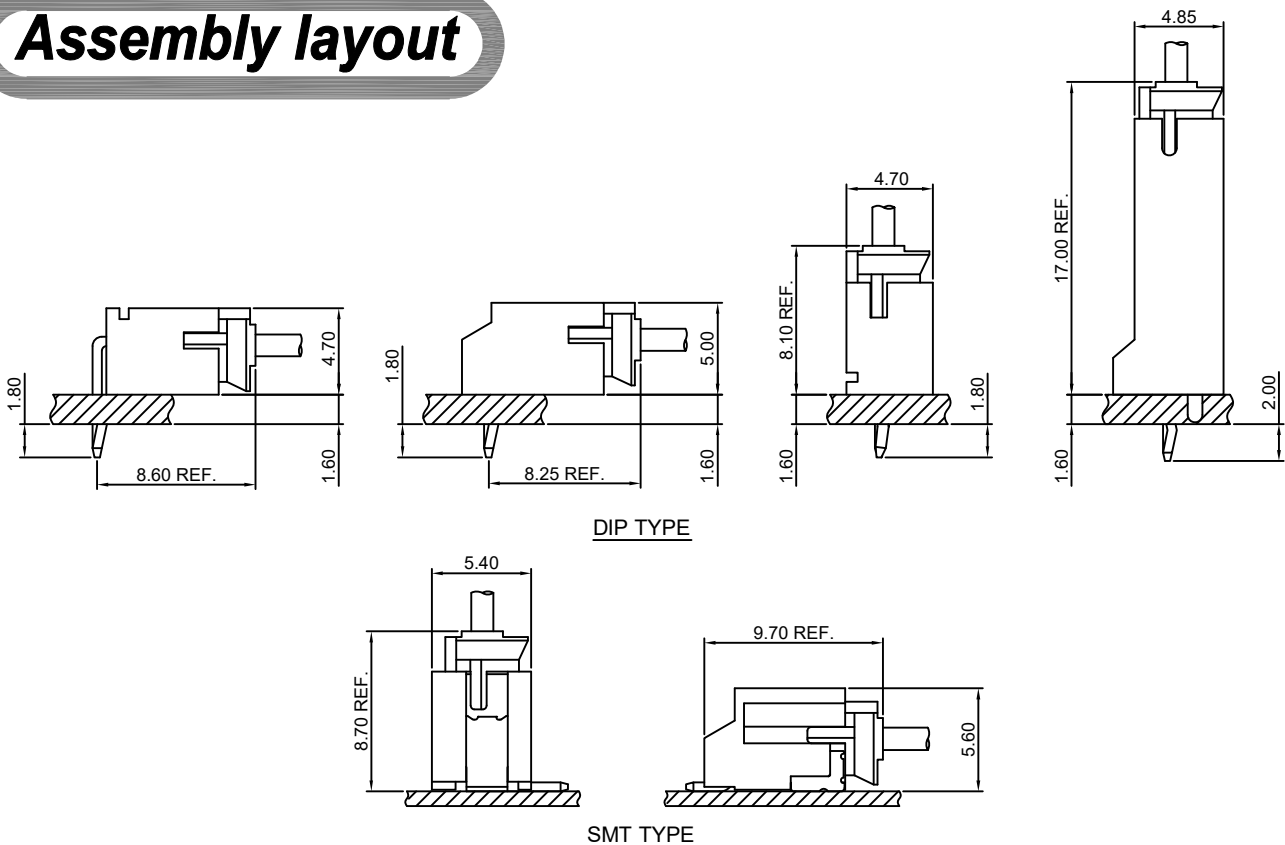



HDGC2001 Series 2.00mm (.079") Pitch Wire to Board and Wire to Wire Connector

HDGC2001-T

2.00mm pitch Crimp Terminal

Reference Informations:

*Used in HDGC2001H-XP series Housing

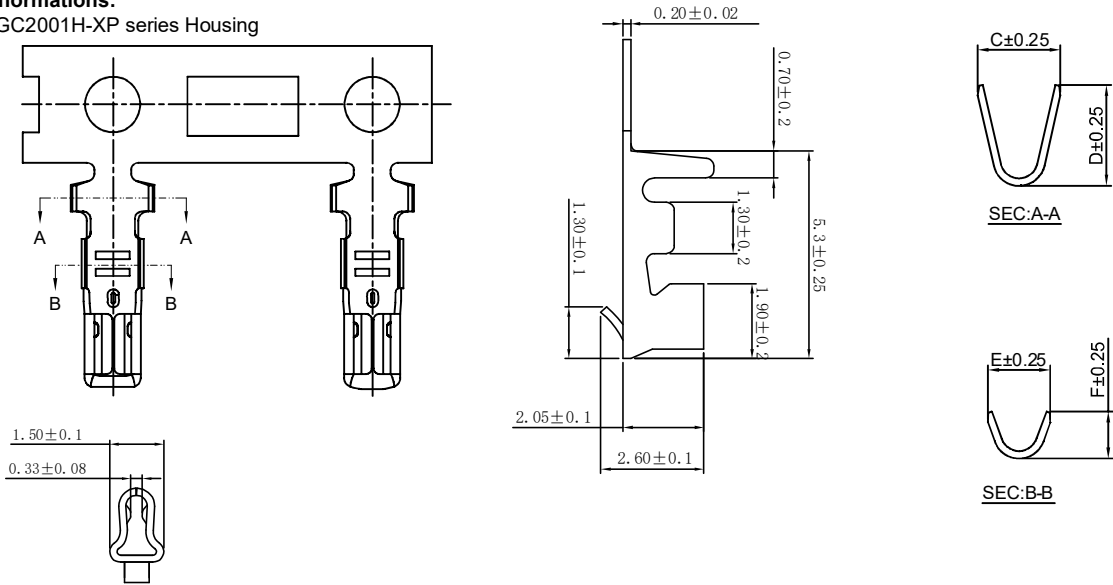

Ordering information & Specifications:

Unit:mm

Part NO.	Wire Range	Insulation O.D.	Material	Finish	C	D	E	F	Qty/reel
HDGC2001-TP	AWG#24-#30	1.50mm(max)	Phosphor Bronze	Tin over Nickel	2.20	2.50	1.70	1.40	10,000 PCS
HDGC2001-GP	AWG#24-#30	1.50mm(max)	Phosphor Bronze	Gold over Nickel	2.20	2.50	1.70	1.40	10,000 PCS
HDGC2001-TP-L	AWG#28-#32	0.90mm(max)	Phosphor Bronze	Tin over Nickel	1.55	2.10	1.15	1.15	15,000 PCS
HDGC2001-GP-L	AWG#28-#32	0.90mm(max)	Phosphor Bronze	Gold over Nickel	1.55	2.10	1.15	1.15	15,000 PCS

Optional Gold plating available but MOQ requested

HDGC2001M-T

2.00mm pitch Crimp Terminal

Reference Informations:

*Used in HDGC2001HM-XP series Housing

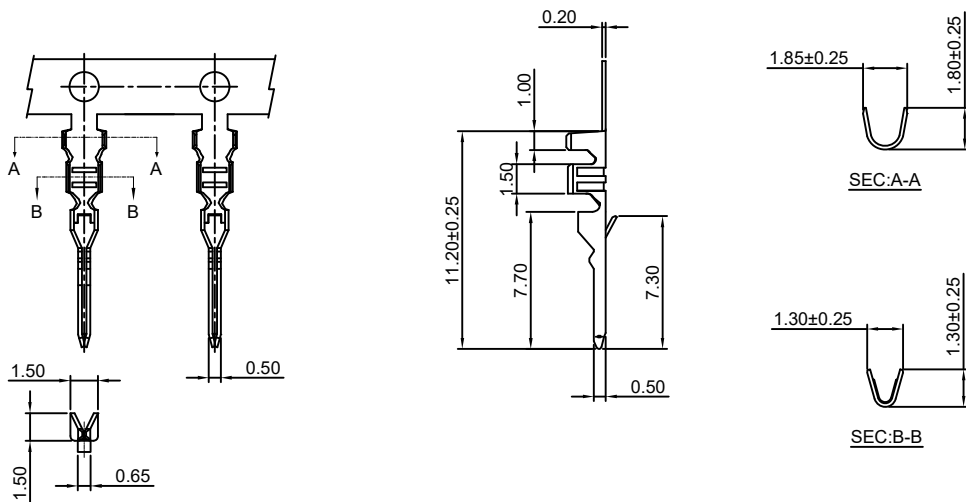

Ordering information & Specifications:

Unit:mm

Part NO	Wire Range	Insulation O.D.	Material	Finish	Qty/reel
HDGC2001M-TP	AWG#24-#30	1.50mm(max)	Phosphor Bronze	Tin over Nickel	10,000 PCS
HDGC2001M-TB	AWG#24-#30	1.50mm(max)	Brass	Tin over Nickel	10,000 PCS
HDGC2001M-GP	AWG#24-#30	1.50mm(max)	Phosphor Bronze	Gold over Nickel	10,000 PCS
HDGC2001M-GB	AWG#24-#30	1.50mm(max)	Brass	Gold over Nickel	10,000 PCS

Optional Gold plating available but MOQ requested



HDGC2001 Series 2.00mm (.079") Pitch Wire to Board and Wire to Wire Connector

HDGC2001H-XP

2.00mm pitch Housing

Reference Informations:

- *Material:Nylon 66,UL94V-0
- *Suitable HDGC2001-T(-L) series Terminal
- *Mates with HDGC2001HM-XP series Housing or HDGC2001WV,WR-XP,WV-S,WR-S-XP series Wafer
- *Color:White

Ordering Information:

HDGC2001H-XP - *** - **
1 2 3

- Part No.
- Material:
(Blank):Nylon 66,UL94V-0
GWT:Nylon 66,UL94V-0,GWT 750 °C
- Color:
(Blank):White
RD:Red
YL:Yellow
BL:Blue
BK:Black
GN:Green
TR:Tomato red
LE:Light blue
DPK:Dark pink
OR:Orange
GY:Gray
PK:Pink
BR:Brown
VI:Violet
LY:Lemon yellow
VY:Vivid yellow

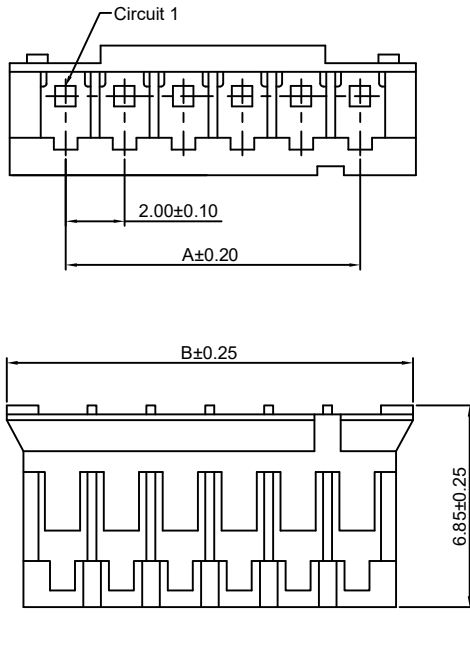
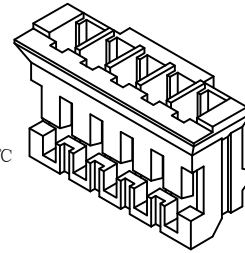

Ordering Information & Dimensions:

PART NO.	Dimensions	
	A	B
2P	2.00	5.80
3P	4.00	7.80
4P	6.00	9.80
5P	8.00	11.80
6P	10.00	13.80
7P	12.00	15.80
8P	14.00	17.80
9P	16.00	19.80
10P	18.00	21.80
11P	20.00	23.80
12P	22.00	25.80
13P	24.00	27.80
14P	26.00	29.80
15P	28.00	31.80
16P	30.00	33.80
17P	32.00	35.80
18P	34.00	37.80
19P	36.00	39.80
20P	38.00	41.80

Unit: mm

HDGC2001HM-XP

2.00mm pitch Housing

Reference Informations:

- *Material:Nylon 66,UL94V-0
- *Suitable HDGC2001M-T series Terminal
- *Mates with HDGC2001H-XP series Housing
- *Color:White

Ordering Information:

HDGC2001HM-XP - *** - **
1 2 3

- Part No.
- Material:
(Blank):Nylon 66,UL94V-0
GWT:Nylon 66,UL94V-0,GWT 750 °C
- Color:
(Blank):White
RD:Red
YL:Yellow
BL:Blue
BK:Black
GN:Green
OR:Orange
GY:Gray
PK:Pink
BR:Brown
VI:Violet

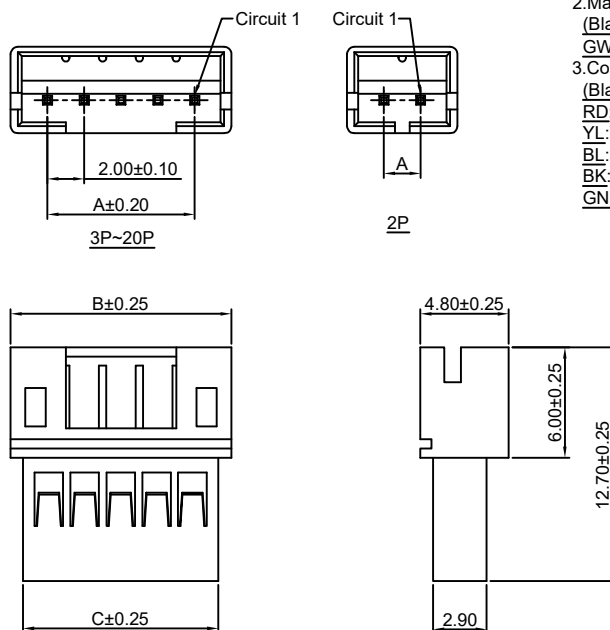

Ordering Information & Dimensions:

PART NO.	Dimensions		
	A	B	C
2P	2.00	6.00	4.60
3P	4.00	8.00	6.60
4P	6.00	10.00	8.60
5P	8.00	12.00	10.60
6P	10.00	14.00	12.60
7P	12.00	16.00	14.60
8P	14.00	18.00	16.60
9P	16.00	20.00	18.60
10P	18.00	22.00	20.60
11P	20.00	24.00	22.60
12P	22.00	26.00	24.60
13P	24.00	28.00	26.60
14P	26.00	30.00	28.60
15P	28.00	32.00	30.60
16P	30.00	34.00	32.60
17P	32.00	36.00	34.60
18P	34.00	38.00	36.60
19P	36.00	40.00	38.60
20P	38.00	42.00	40.60

Unit: mm



HDGC2001 Series 2.00mm (.079") Pitch Wire to Board and Wire to Wire Connector

HDGC2001WV-XP

2.00mm pitch 180° Wafer

Reference Informations:

- *Material: Pin: Brass/Tin over Nickel
Insulator: Nylon 66, UL94V-0
- *Mates with HDGC2001H-XP series Housing
- *Color: White

Ordering Information:
HDGC2001WV-XP - * - *** - ** - **
1 2 3 4 5

- Part No.
- Style:
(blank) : Type 1
2 : Type 2
3 : Type 3
- Material:
(Blank): Nylon 66, UL94V-0
GWT: Nylon 66, UL94V-0, GWT 750 °C
- Color:
(Blank): White
RD: Red OR: Orange
YL: Yellow GY: Gray
BL: Blue PK: Pink
BK: Black BR: Brown
GN: Green VI: Violet
TR: Tomato red LY: Lemon yellow
LE: Light blue VY: Vivid yellow
- Finish:
(Blank): Tin over Nickel
G: Gold over Nickel

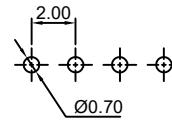
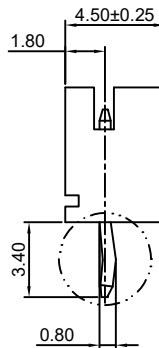
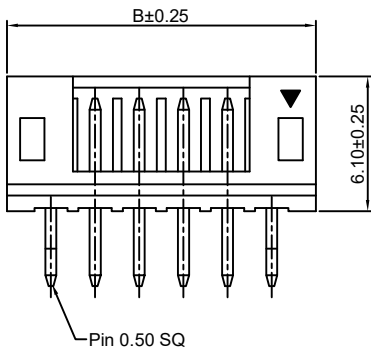
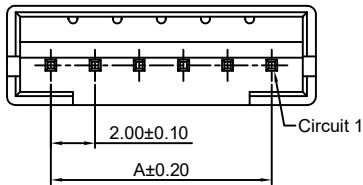

P.C.B LAYOUT

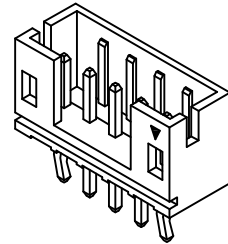

Ordering Information & Dimensions:

PART NO.	Dimensions	
	A	B
2P	2.00	6.00
3P	4.00	8.00
4P	6.00	10.00
5P	8.00	12.00
6P	10.00	14.00
7P	12.00	16.00
8P	14.00	18.00
9P	16.00	20.00
10P	18.00	22.00
11P	20.00	24.00
12P	22.00	26.00
13P	24.00	28.00
14P	26.00	30.00
15P	28.00	32.00
16P	30.00	34.00
17P	32.00	36.00
18P	34.00	38.00
19P	36.00	40.00
20P	38.00	42.00

Unit: mm

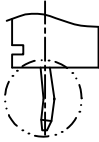

TYPE 1

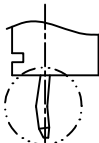

TYPE 2

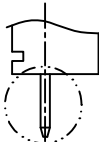

TYPE 3

HDGC2001WR-XP

2.00mm pitch 90° Wafer

Reference Informations:

- *Material: Pin: Brass/Tin over Nickel
Insulator: Nylon 66, UL94V-0
- *Mates with HDGC2001H-XP series Housing
- *Color: White

Ordering Information:
HDGC2001WR-XP - * - *** - ** - **
1 2 3 4 5

- Part No.
- Style:
(blank) : Type 1
2 : Type 2
- Material:
(Blank): Nylon 66, UL94V-0
GWT: Nylon 66, UL94V-0, GWT 750 °C
- Color:
(Blank): White OR: Orange
RD: Red GY: Gray
YL: Yellow GY: Gray
BL: Blue PK: Pink
BK: Black BR: Brown
GN: Green VI: Violet
TR: Tomato red LY: Lemon yellow
LE: Light blue VY: Vivid yellow
- Finish:
(Blank): Tin over Nickel
G: Gold over Nickel

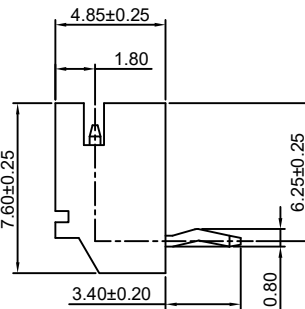
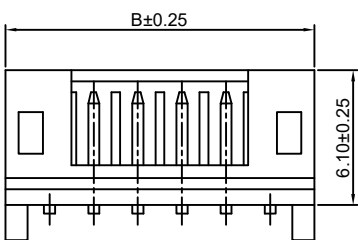
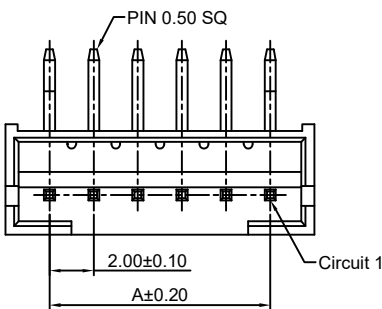

TYPE 1

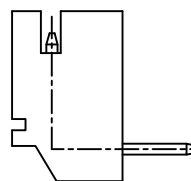

TYPE 2

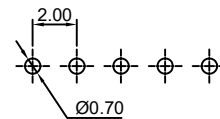

P.C.B LAYOUT

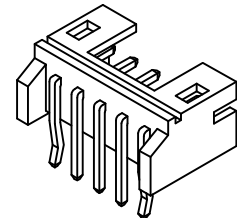

Ordering Information & Dimensions:

PART NO.	Dimensions	
	A	B
2P	2.00	6.00
3P	4.00	8.00
4P	6.00	10.00
5P	8.00	12.00
6P	10.00	14.00
7P	12.00	16.00
8P	14.00	18.00
9P	16.00	20.00
10P	18.00	22.00
11P	20.00	24.00
12P	22.00	26.00
13P	24.00	28.00
14P	26.00	30.00
15P	28.00	32.00
16P	30.00	34.00
17P	32.00	36.00
18P	34.00	38.00
19P	36.00	40.00
20P	38.00	42.00

Unit: mm



HDGC2001 Series 2.00mm (.079") Pitch Wire to Board and Wire to Wire Connector

HDGC2001WV-S-XP

2.00mm pitch 180° Wafer-SMT TYPE

Reference Informations:

- *Material: Pin: Brass/Tin over Nickel
Insulator: Nylon 6T, UL94V-0
- *Mates with HDGC2001H-XP series Housing
- *Color: Ivory

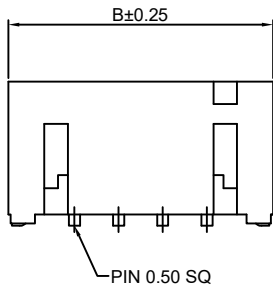
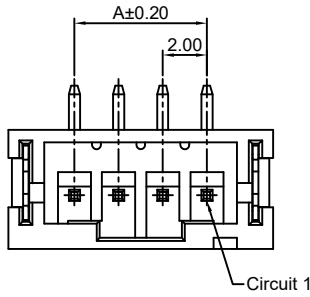

- Ordering Information:
HDGC2001WV-S-XP - ^{***}/₁ - ^{**}/₂ - ^{**}/₃ - ^{**}/₄
- Part No.
 - Material:
(Blank): Nylon 6T, UL94V-0
GWT: Nylon 6T, UL94V-0, GWT 750 °C
 - Color:
(Blank): Ivory
RD: Red BL: Blue
BK: Black GN: Green
LY: Lemon yellow DPK: Dark pink
 - Finish:
(Blank): Tin over Nickel
G: Gold over Nickel

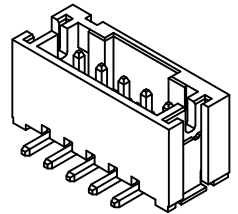
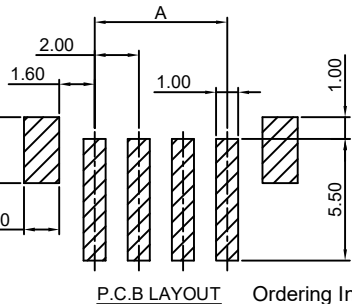

Ordering Information & Dimensions:

PART NO.	Dimensions	
	A	B
2P	2.00	8.00
3P	4.00	10.00
4P	6.00	12.00
5P	8.00	14.00
6P	10.00	16.00
7P	12.00	18.00
8P	14.00	20.00
9P	16.00	22.00
10P	18.00	24.00
11P	20.00	26.00
12P	22.00	28.00
13P	24.00	30.00
14P	26.00	32.00
15P	28.00	34.00
16P	30.00	36.00
17P	32.00	38.00
18P	34.00	40.00
19P	36.00	42.00
20P	38.00	44.00

Unit: mm

HDGC2001WR-S-XP

2.00mm pitch 90° Wafer-SMT TYPE

Reference Informations:

- *Material: Pin: Brass/Tin over Nickel
Insulator: Nylon 6T, UL94V-0
- *Mates with HDGC2001H-XP series Housing
- *Color: Ivory

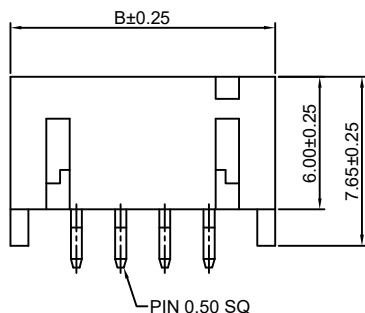
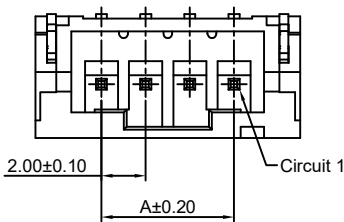

- Ordering Information:
HDGC2001WR-S-XP - ^{***}/₁ - ^{**}/₂ - ^{**}/₃ - ^{**}/₄
- Part No.
 - Material:
(Blank): Nylon 6T, UL94V-0
GWT: Nylon 6T, UL94V-0, GWT 750 °C
 - Color:
(Blank): Ivory
RD: Red BL: Blue
BK: Black GN: Green
LY: Lemon yellow DPK: Dark pink
 - Finish:
(Blank): Tin over Nickel
G: Gold over Nickel

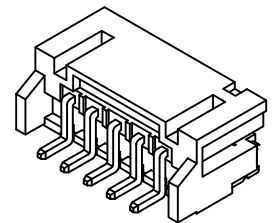
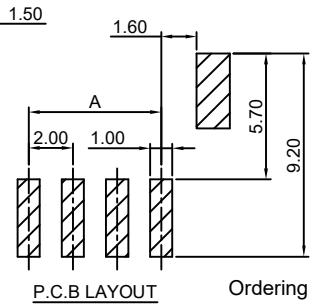

Ordering Information & Dimensions:

PART NO.	Dimensions	
	A	B
2P	2.00	8.00
3P	4.00	10.00
4P	6.00	12.00
5P	8.00	14.00
6P	10.00	16.00
7P	12.00	18.00
8P	14.00	20.00
9P	16.00	22.00
10P	18.00	24.00
11P	20.00	26.00
12P	22.00	28.00
13P	24.00	30.00
14P	26.00	32.00
15P	28.00	34.00
16P	30.00	36.00
17P	32.00	38.00
18P	34.00	40.00
19P	36.00	42.00
20P	38.00	44.00

Unit: mm



HDGC2001 Series 2.00mm (.079") Pitch Wire to Board and Wire to Wire Connector

HDGC2001WVR-XP

2.00mm pitch 90° Wafer

Reference Informations:

- *Material: Pin: Brass/Tin over Nickel
Insulator: Nylon 66, UL94V-0
- *Mates with HDGC2001H-XP series Housing
- *Color: White

- Ordering Information:
HDGC2001WVR-XP - * - *** - ** - **
 1 2 3 4 5
- Part No.
 - Style:
(blank) : Type 1
2 : Type 2
 - Material:
(Blank): Nylon 66, UL94V-0
GWT: Nylon 66, UL94V-0, GWT 750 °C
 - Color:
(Blank): White
RD: Red OR: Orange
YL: Yellow GY: Gray
BL: Blue PK: Pink
BK: Black BR: Brown
GN: Green VI: Violet
 - Finish:
(Blank): Tin over Nickel
G: Gold over Nickel

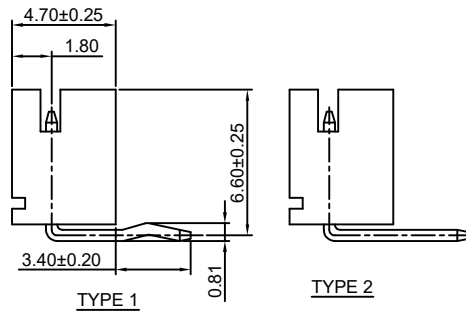
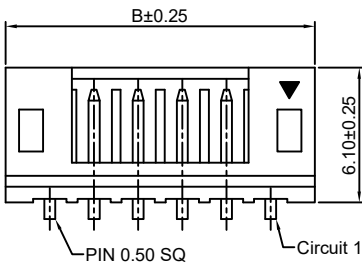
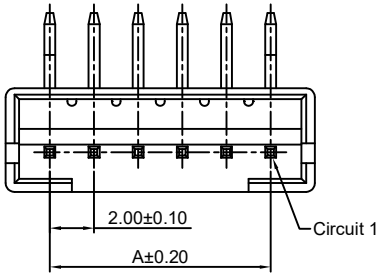
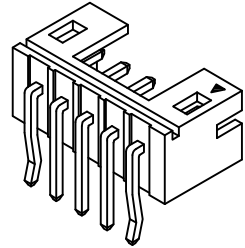
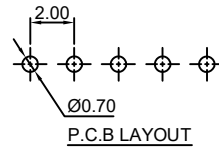

Ordering Information & Dimensions:

PART NO.	Dimensions	
	A	B
2P	2.00	6.00
3P	4.00	8.00
4P	6.00	10.00
5P	8.00	12.00
6P	10.00	14.00
7P	12.00	16.00
8P	14.00	18.00
9P	16.00	20.00
10P	18.00	22.00
11P	20.00	24.00
12P	22.00	26.00
13P	24.00	28.00
14P	26.00	30.00
15P	28.00	32.00
16P	30.00	34.00
17P	32.00	36.00
18P	34.00	38.00
19P	36.00	40.00
20P	38.00	42.00

Unit: mm

HDGC2001WV-F-XP-H

2.00mm pitch 180° Wafer-High box type

Reference Informations:

- *Material: Pin: Brass/Tin over Nickel
Insulator: Nylon 6T, UL94V-0
- *Mates with HDGC2001H-XP series Housing
- *Color: White

- Ordering Information:
HDGC2001WV-F-XP-H - *** - ** - **
 1 2 3 4
- Part No.
 - Material:
(Blank): Nylon 6T, UL94V-0
GWT: Nylon 6T, UL94V-0, GWT 750 °C
 - Color:
(Blank): White
RD: Red YL: Yellow
BL: Blue BK: Black
BR: Brown GN: Green
 - Finish:
(Blank): Tin over Nickel
G: Gold over Nickel

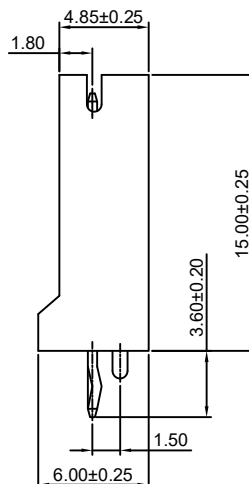
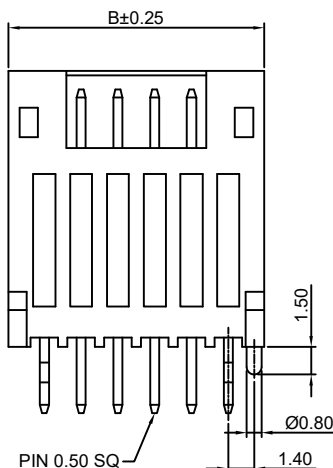
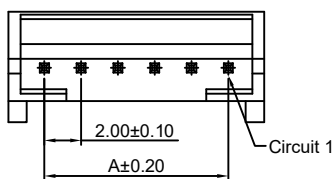
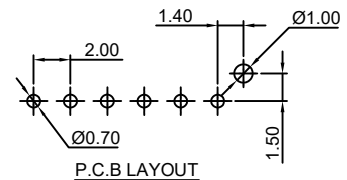

Ordering Information & Dimensions:

PART NO.	Dimensions	
	A	B
2P	2.00	6.00
3P	4.00	8.00
4P	6.00	10.00
5P	8.00	12.00
6P	10.00	14.00
7P	12.00	16.00
8P	14.00	18.00
9P	16.00	20.00
10P	18.00	22.00
11P	20.00	24.00
12P	22.00	26.00
13P	24.00	28.00
14P	26.00	30.00
15P	28.00	32.00
16P	30.00	34.00
17P	32.00	36.00
18P	34.00	38.00
19P	36.00	40.00
20P	38.00	42.00

Unit: mm