

Specifications

- Current rating:10A AC,DC
- Voltage rating:250V AC,DC
- Temperature range:-25°C~+85°C
- Contact resistance:10mΩMax.
- Insulation resistance:1000MΩMin.
- Withstanding voltage:1500V AC/minute
- *Compliant with RoHS and REACH*
- *Meet the HF/Halogen Free,GWT/Glow wire Test (IEC60335-1) request,need to customize*
- *Contact HDGC for details*

Assembly layout

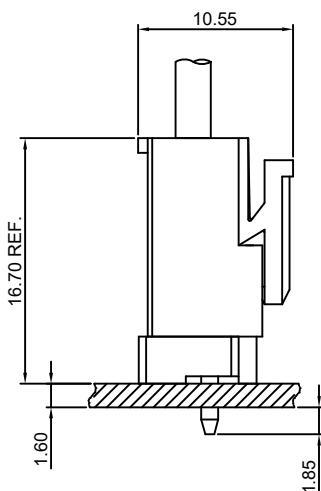



HDGC5001 Series 5.00mm (.197") Pitch Wire to Board Connector

HDGC5001H-XP

5.00mm pitch Housing

Reference Informations:

- *Material:Nylon 66,UL94V-0
- *Suitable HDGC3963-T(-H) series Terminal
- *Mates with HDGC5001WV-XP series Wafer
- *Color:White

Ordering Information:

- HDGC5001H-XP - ***
- 1 2
- 1.Part No.
- 2.Material:
- (blank):Nylon 66, UL94V-0
- GWT:Nylon 66, UL94V-0,GWT 750°C

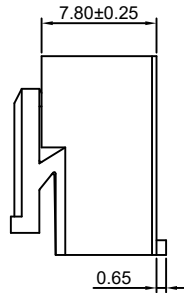
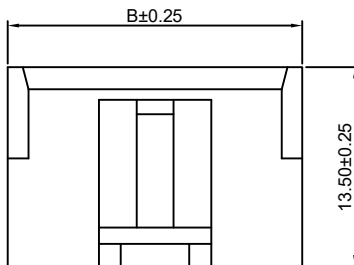
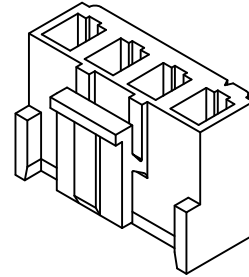
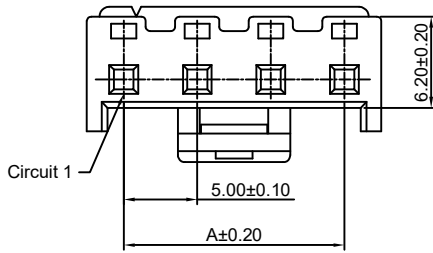

Ordering Information & Dimensions:

PART NO.	Dimensions	
	A	B
2P	5.00	10.00
3P	10.00	15.00
4P	15.00	20.00

Unit: mm

HDGC5001HA-XP

5.08mm pitch Housing

Reference Informations:

- *Material:Nylon 66,UL94V-0
- *Suitable HDGC3963-T(-H) series Terminal
- *Mates with HDGC5001WVA,WRA-XP series Wafer
- *Color:Natural

Ordering Information:

- HDGC5001HA-XP - ***
- 1 2
- 1.Part No.
- 2.Material:
- (blank):Nylon 66, UL94V-0
- GWT:Nylon 66, UL94V-0,GWT 750°C

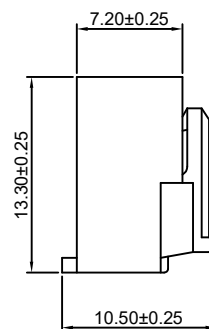
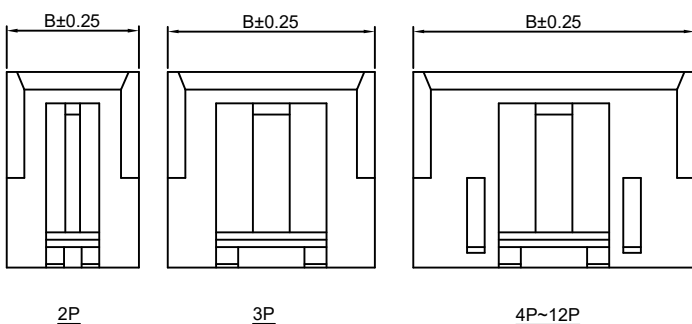
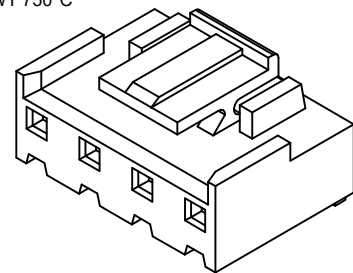
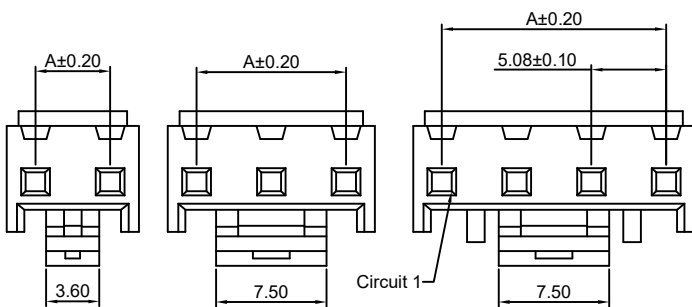

Ordering Information & Dimensions:

PART NO.	Dimensions	
	A	B
2P	5.08	8.98
3P	10.16	14.06
4P	15.24	19.14
5P	20.32	24.22
6P	25.40	29.30
7P	30.48	34.38
8P	35.56	39.46
9P	40.64	44.54
10P	45.72	49.62
11P	50.80	54.70
12P	55.88	59.78

Unit: mm



HDGC5001 Series 5.00mm (.197") Pitch Wire to Board Connector

HDGC5001WV-XP

5.00mm pitch 180° Wafer

Reference Informations:

- *Material:Pin:Brass/Tin over Nickel
Insulator:Nylon 66,UL94V-0
- *Mates with HDGC5001H-XP series Housing
- *Color:White

Ordering Information:
HDGC5001WV-XP - ***
 $\frac{1}{2}$
 1.Part No.
 2.Material:
 (blank):Nylon 66, UL94V-0
 GWT:Nylon 66, UL94V-0,GWT 750°C

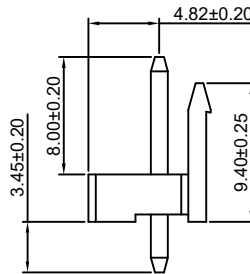
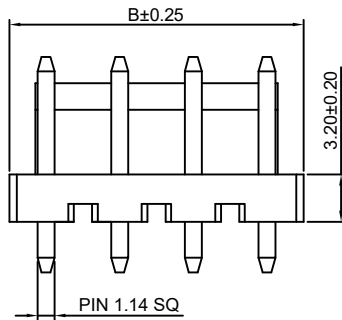
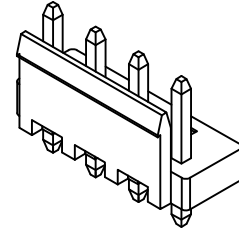
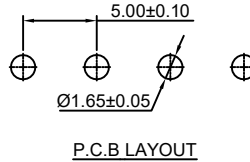
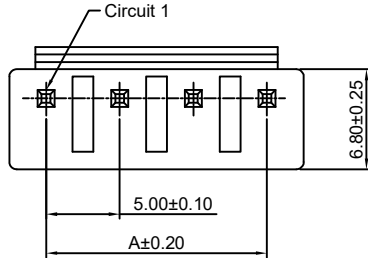

Ordering Information & Dimensions:

PART NO.	Dimensions	
	A	B
2P	5.00	10.00
3P	10.00	15.00
4P	15.00	20.00

Unit: mm

HDGC5001WVA-XP

5.08mm pitch 180° Wafer

Reference Informations:

- *Material:Pin:Brass/Tin over Nickel
Insulator:Nylon 66,UL94V-0
- *Mates with HDGC5001HA-XP series Housing
- *Color:White

Ordering Information:
HDGC5001WVA-XP - ***
 $\frac{1}{2}$
 1.Part No.
 2.Material:
 (blank):Nylon 66, UL94V-0
 GWT:Nylon 66, UL94V-0,GWT 750°C

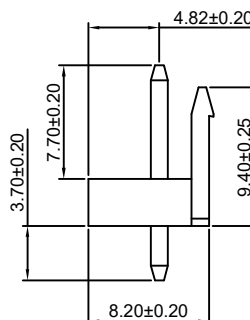
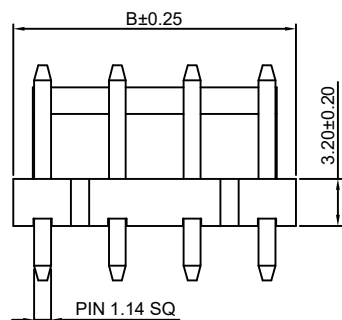
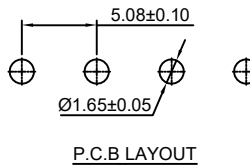
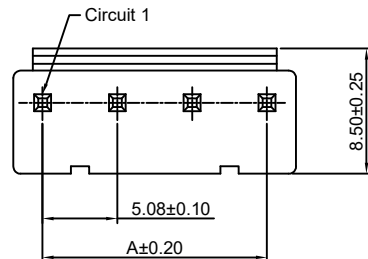

Ordering Information & Dimensions:

PART NO.	Dimensions	
	A	B
2P	5.08	9.04
3P	10.16	14.12
4P	15.24	19.20
5P	20.32	24.28
6P	25.40	29.36
7P	30.48	34.44
8P	35.56	39.52
9P	40.64	44.60
10P	45.72	49.68
11P	50.80	54.76
12P	55.88	59.84

Unit: mm



HDGC5001 Series 5.00mm (.197") Pitch Wire to Board Connector

HDGC5001WVA-F-XP

5.08mm pitch 180° Wafer With Foot

Reference Informations:

- *Material:Pin:Brass/Tin over Nickel
Insulator:Nylon 66,UL94V-0
- *Mates with HDGC5001HA-XP series Housing
- *Color:White

Ordering Information:
HDGC5001WVA-F-XP - ***
1 2

- 1.Part No.
- 2.Material:
(blank):Nylon 66, UL94V-0
GWT:Nylon 66, UL94V-0,GWT 750°C

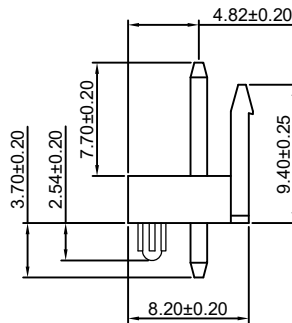
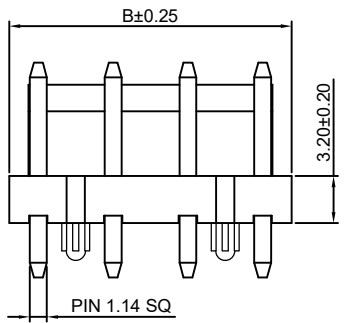
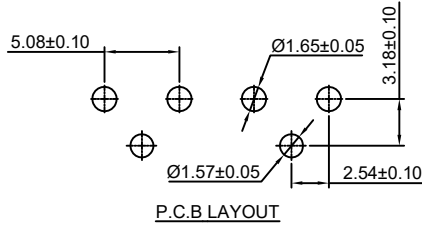
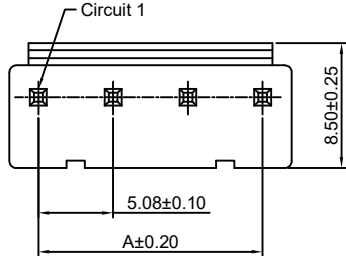

Ordering Information & Dimensions:

PART NO.	Dimensions	
	A	B
2P	5.08	9.04
3P	10.16	14.12
4P	15.24	19.20
5P	20.32	24.28
6P	25.40	29.36
7P	30.48	34.44
8P	35.56	39.52
9P	40.64	44.60
10P	45.72	49.68
11P	50.80	54.76
12P	55.88	59.84

Unit: mm

HDGC5001WRA-XP

5.08mm pitch 90° Wafer

Reference Informations:

- *Material:Pin:Brass/Tin over Nickel
Insulator:Nylon 66,UL94V-0
- *Mates with HDGC5001HA-XP series Housing
- *Color:White

Ordering Information:
HDGC5001WRA-XP - ***
1 2

- 1.Part No.
- 2.Material:
(blank):Nylon 66, UL94V-0
GWT:Nylon 66, UL94V-0,GWT 750°C

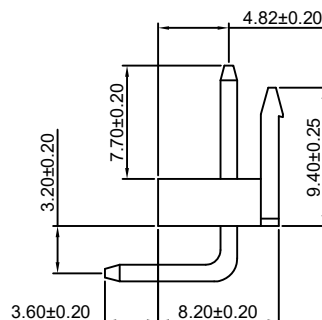
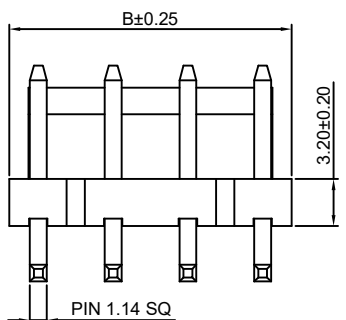
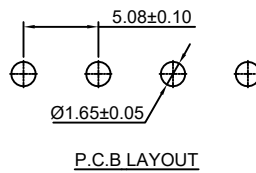
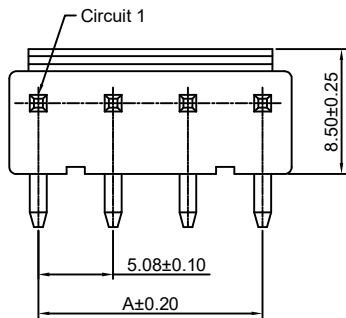

Ordering Information & Dimensions:

PART NO.	Dimensions	
	A	B
2P	5.08	9.04
3P	10.16	14.12
4P	15.24	19.20
5P	20.32	24.28
6P	25.40	29.36
7P	30.48	34.44
8P	35.56	39.52
9P	40.64	44.60
10P	45.72	49.68
11P	50.80	54.76
12P	55.88	59.84

Unit: mm