

修订 REV	标记 MARK	修改摘要 REVISION DESCRIPTION	签名 SIGNATURE	日期 DATE
AO		NEW RELEASE	WANG	2022-01-10

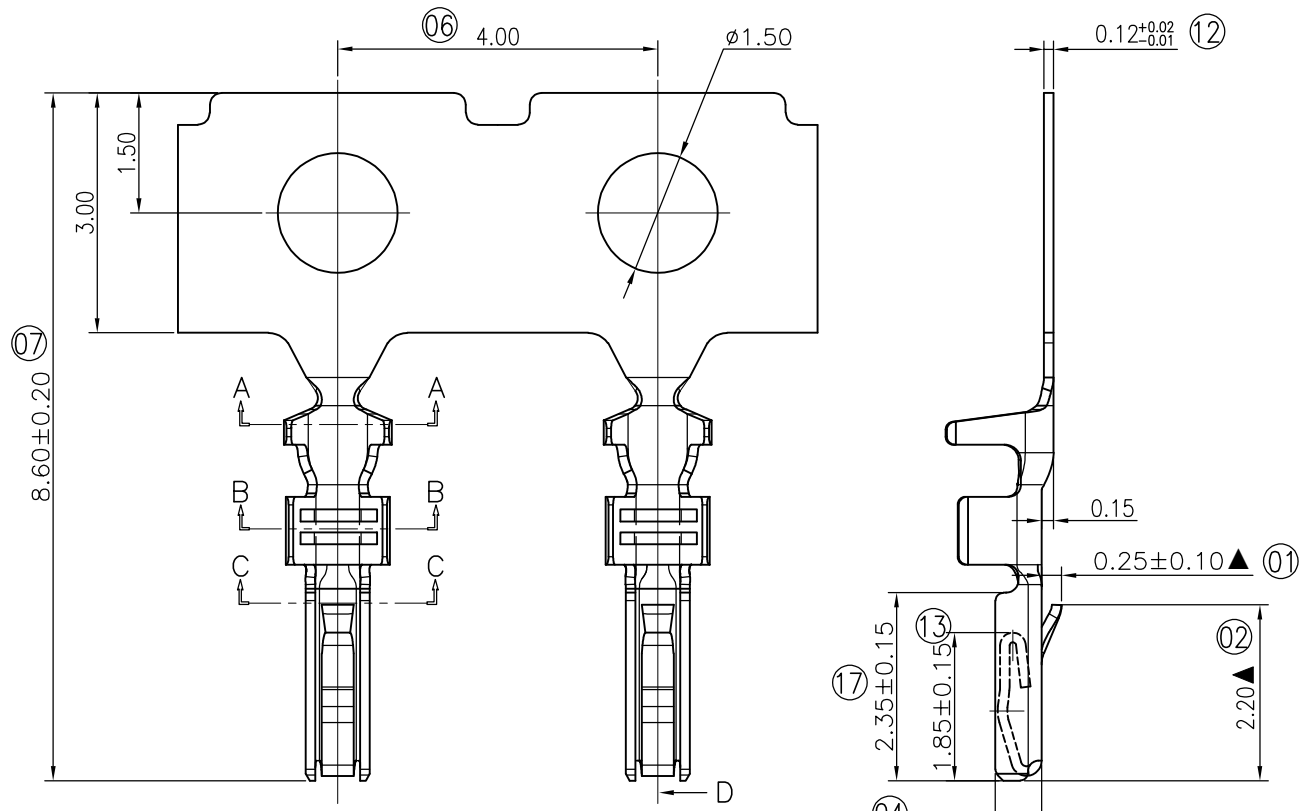

NOTES:
1.材质:C5191R-H (T=0.12mm);

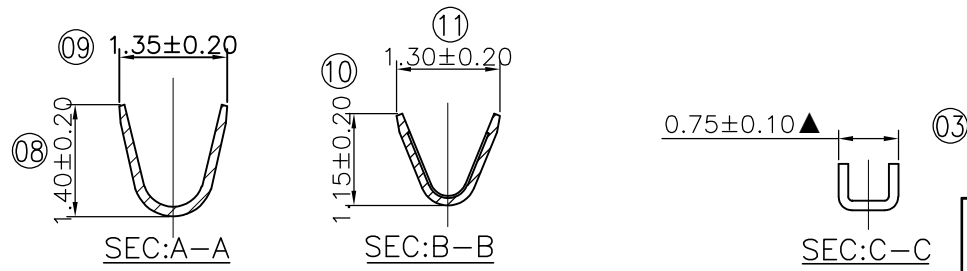

		深圳市华德共创科技有限公司 Shenzhen Huade co-create Technology Co.,LTD TEL : 0755-27129737 FAX : 0755-29940187									
		-TOLERANCES- UNLESS OTHERWISE SPECIFIED 公差参数表				TITLE: 1.00mm Pitch 产品名称: Crimp Terminal					
X.X	±0.30	X.X°	±3°	APPD: 核准:	XIE			PART NO: 产品编号:		HDGC1009-T	
X.XX	±0.30	X.XX°	±2°	CHECK: 校对:	WANG			DATE	SCALE	UNIT	CODE NUMBER
X.XXX	±0.10	X.XXX°	±1°	DRAW: 绘图:	WANG			2022-01-10	1:1	mm	A001

修订 REV	标记 MARK	修改摘要 REVISION DESCRIPTION	签名 SIGNATURE	日期 DATE
A0		NEW RELEASE	WANG	2022-01-10

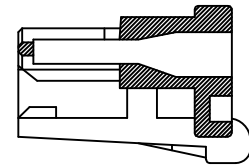
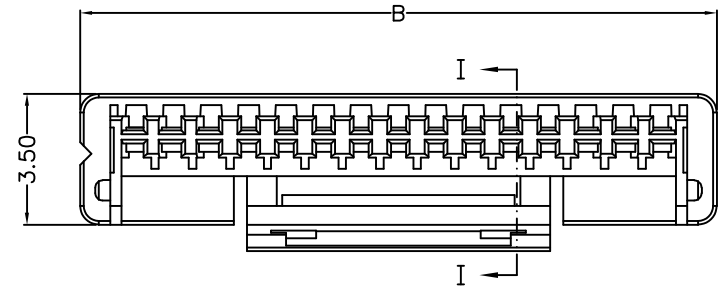

SECTION I-I

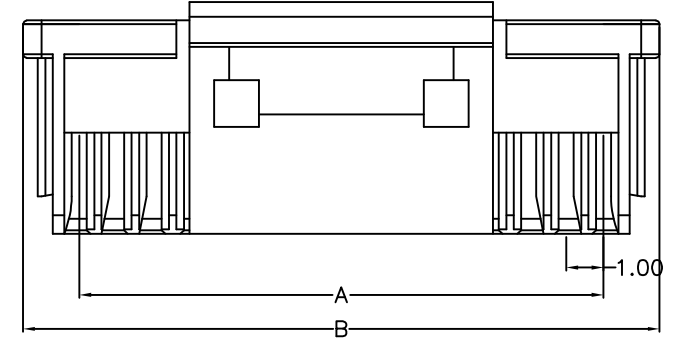

10P~15P

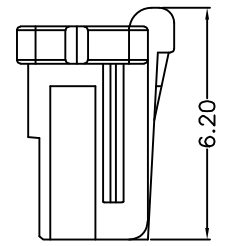
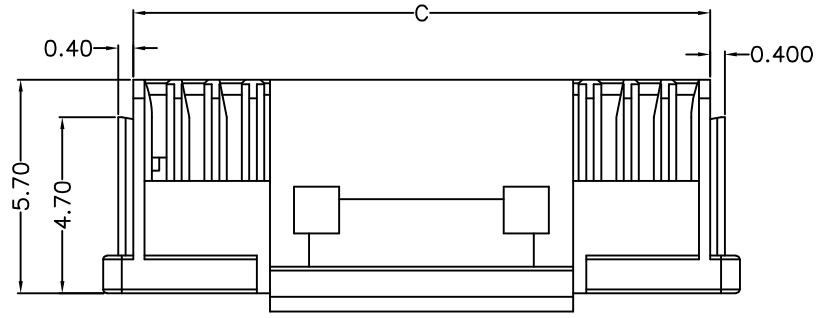

PIN	A	B	C	D
2P	2.00	5.00	3.40	2.00
3P	2.00	5.00	3.40	2.00
4P	3.00	6.00	4.40	2.00
5P	4.00	7.00	5.40	3.40
6P	5.00	8.00	6.40	4.30
7P	6.00	9.00	7.40	4.30
8P	7.00	10.00	8.40	4.30
9P	8.00	11.00	9.40	4.30
10P	9.00	12.00	10.40	6.15
11P	10.00	13.00	11.40	6.15
12P	11.00	14.00	12.40	6.15
13P	12.00	15.00	13.40	6.15
14P	13.00	16.00	14.40	8.10
15P	14.00	17.00	15.40	8.10

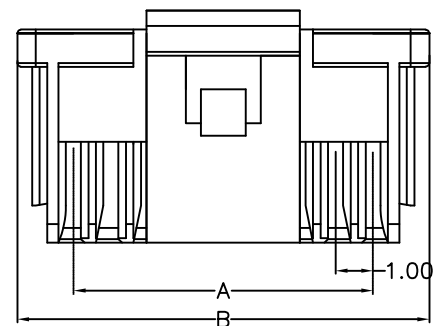
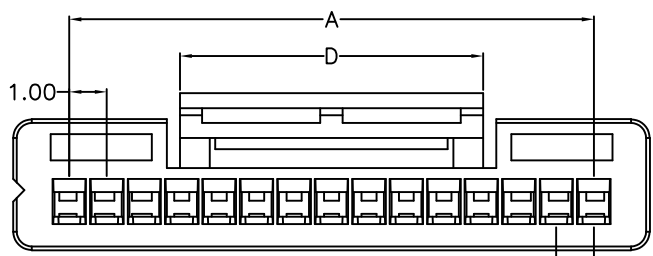

4P~9P

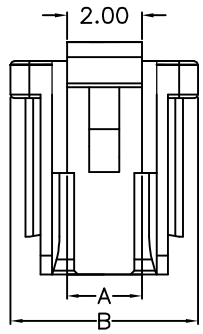

2P

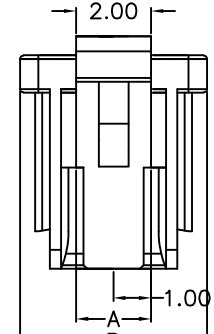

3P

材质: PA66 UL94-V0

HDGC 深圳市华德共创科技有限公司
 Shenzhen Huade co-create Technology Co.,LTD
 TEL : 0755-27129737 FAX : 0755-29940187

-TOLERANCES- UNLESS OTHERWISE SPECIFIED 公差参数表						TITLE: 产品名称: 1.00mm Pitch Housing			
X.X	±0.30	X.X°	±3°	APPD: 核准:	XIE	PART NO: 产品编号: HDGC1009H-XP			
X.XX	±0.30	X.XX°	±2°	CHECK: 校对:	WANG	DATE	SCALE	UNIT	CODE NUMBER
X.XXX	±0.10	X.XXX°	±1°	DRAW: 绘图:	WANG	2022-01-10	1:1	mm	A001